



 **BFR Termica** Portoncini di ingresso



Estetica e
funzionalità'

Porte di ingresso

Le porte di ingresso Termica conferiscono ad una casa personalita', sicurezza, tranquillita', e il Design che il cliente sempre sognato. Le porte Termica sono realizzate con materiali di 1° qualita'.

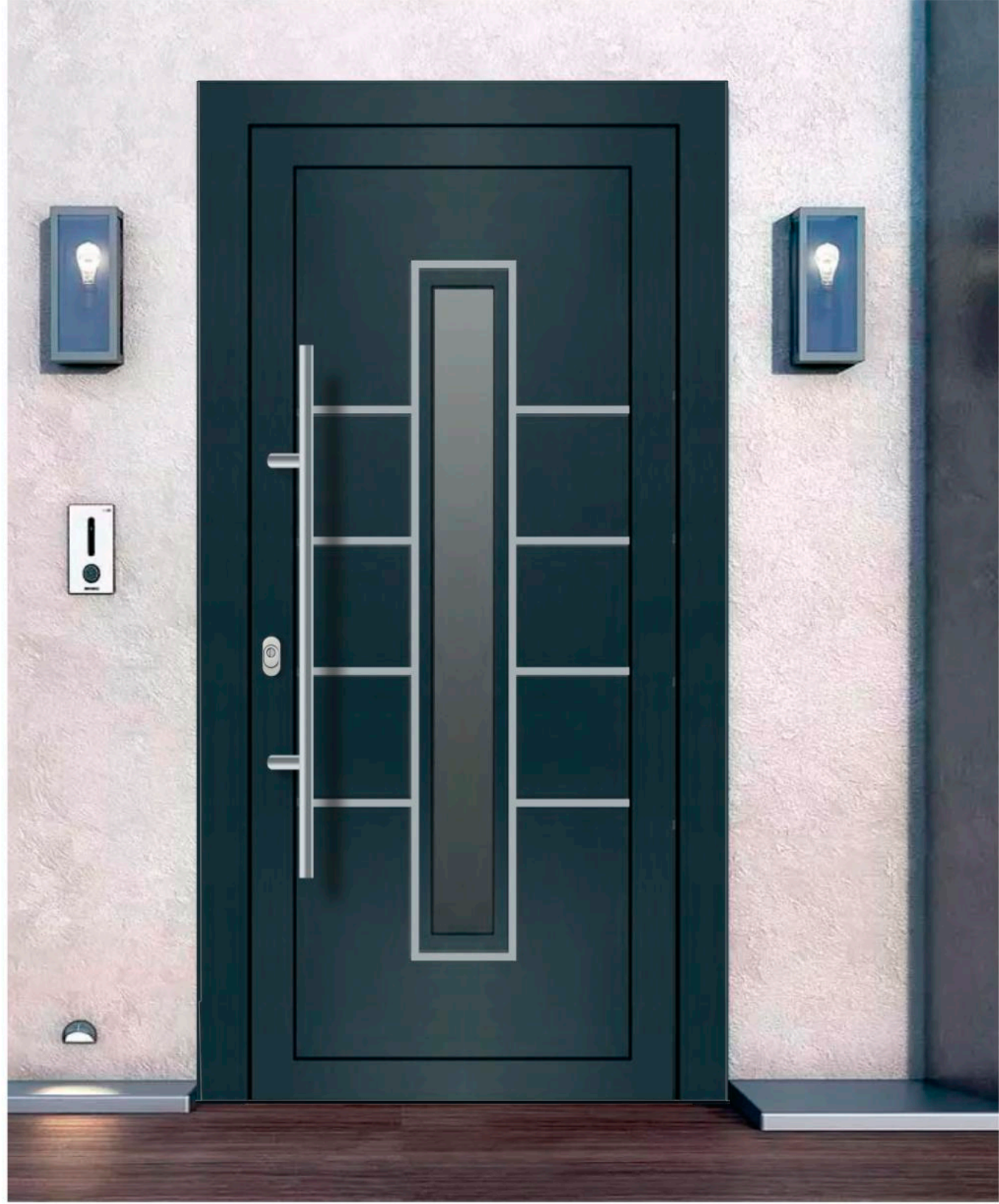

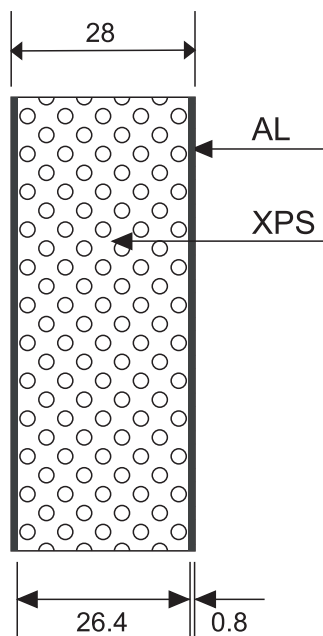

Pannelli Alluminio

I pannelli sono realizzati in Alluminio.
 Prodotti con una tecnologia all'avanguardia, hanno diverse composizioni interne e sono disponibili in diversi spessori: 28 mm – 44 mm – 52 mm.

NB. gli inserti in Alluminio sono applicati sopra al pannello.



Standard: L1000 / H2100



Serie
Termica
Alluminio

La serie TERMICA ALLUMINIO e' realizzata in un vasto numero di modelli per soddisfare le esigenze di ogni cliente. Linee moderne e pulite che possono essere inserite in qualsiasi tipo di soluzione abitativa.

Elevato standard di sicurezza, materiali di 1° qualita', massima attenzione ai dettagli, svariate combinazioni di colori e accessori, tutto questo rende unico ogni modello. Un equilibrio di soluzioni per far diventare la porta di ingresso il simbolo di casa.





T 2009



T 1835



T 2005



T 2007



T 2006

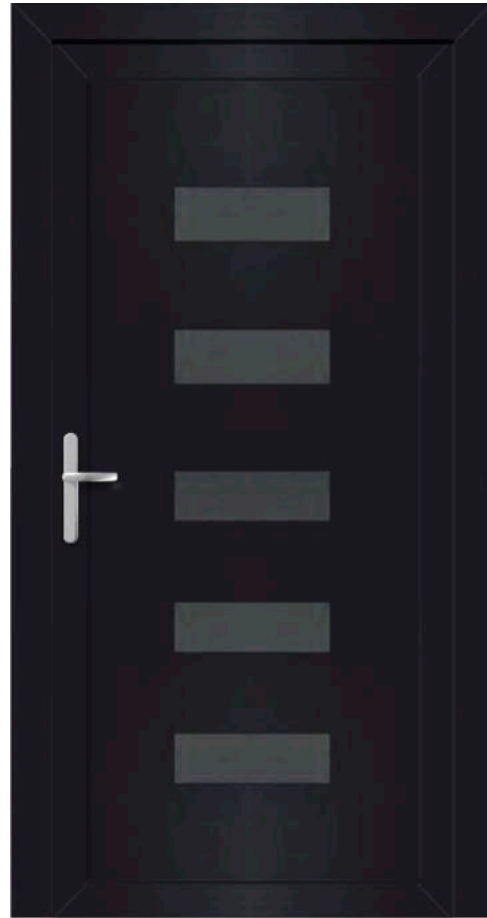

T 2002



T 2007A



T 2006A



T 2003



T 1473



T 1826



T 1436



T 2008



T 2001

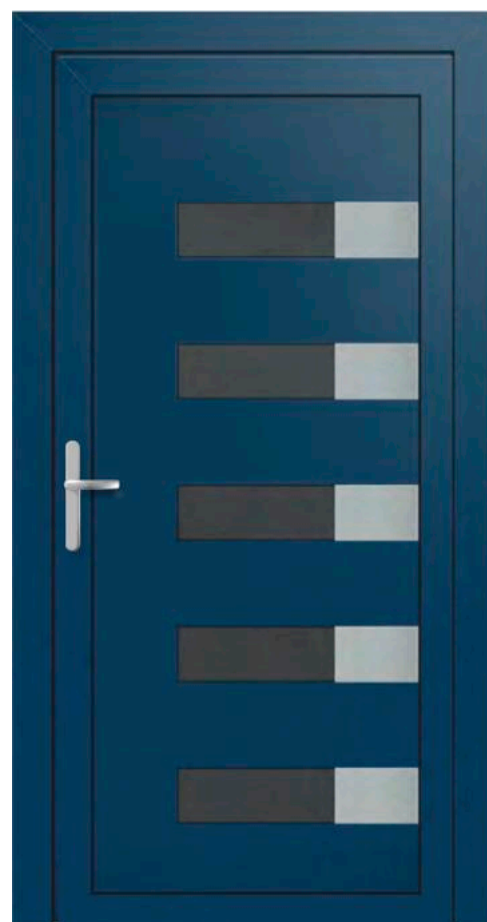

T 2002A



T 1482



T 1432

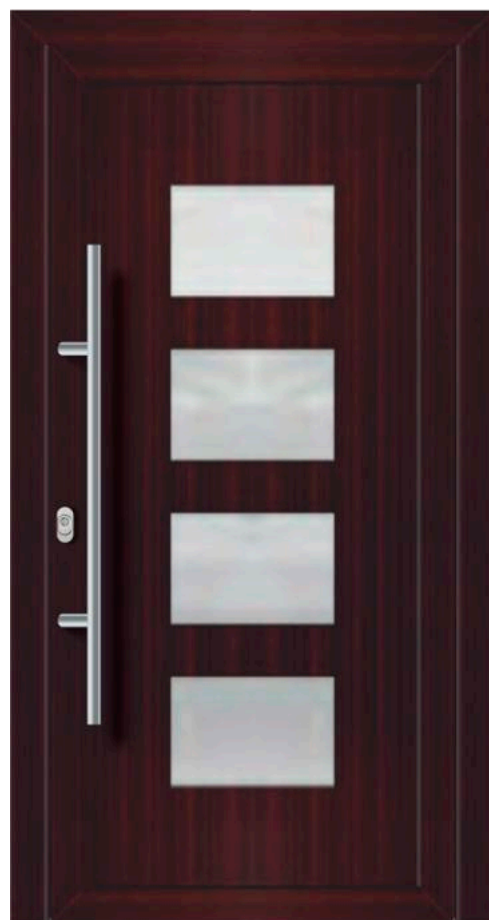

T 1430



T 1828

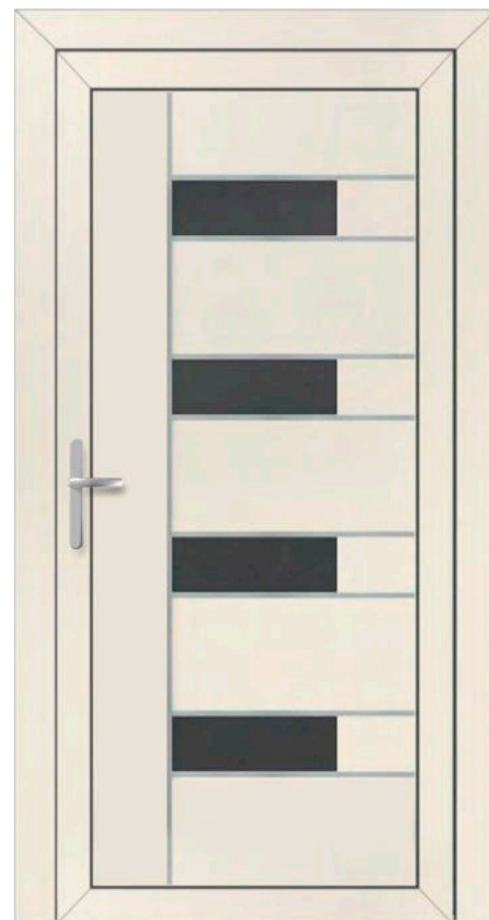

T 1829



T 1830



T 1836



T 2008A



T 1419



T 1425



T 1421



T 1428



T 1401



T 1820



T 1823



T 1825



T 1412



T 1407



T 1833

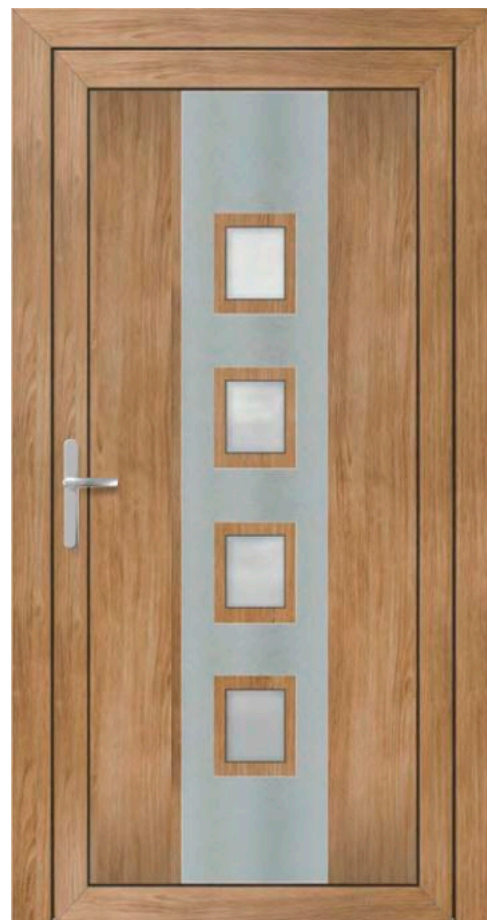

T 1832



T 1404

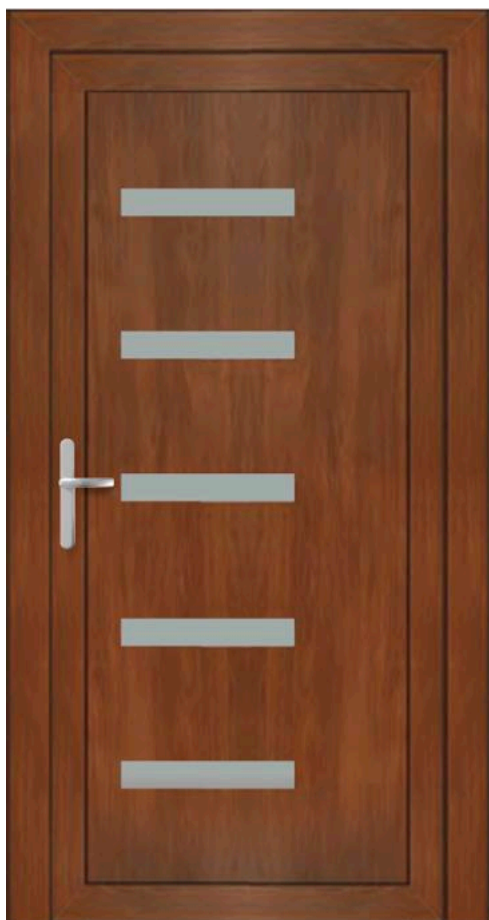

T 1406



T 2005



T 2004



Esprimi la tua creativit  con
l'aiuto dei nostri designer per
personalizzare il modello che
preferisci.

Serie
Termica
Dru



Nella serie TERMICA DRU i modelli hanno forme ben definite; le perfette proporzioni geometriche con le quali vengono realizzati i vetri sabbiati, i dettagli applicati, i vetri in fusione e l'armonia tra i materiali contribuiscono a creare una porta esteticamente eccezionale. In questa serie viene espressa la personalita' della proprieta' di Termica. Grazie alla serie Dru vengono toccati i piu' alti standard estetici.





DRU 2

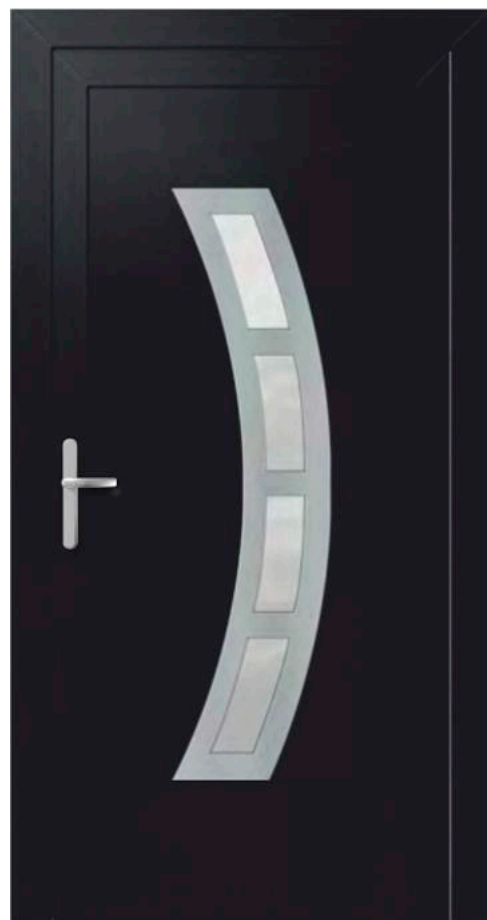

DRU 6



DRU 7



DRU 1



DRU 3



DRU 9



DRU 5



DRU 13

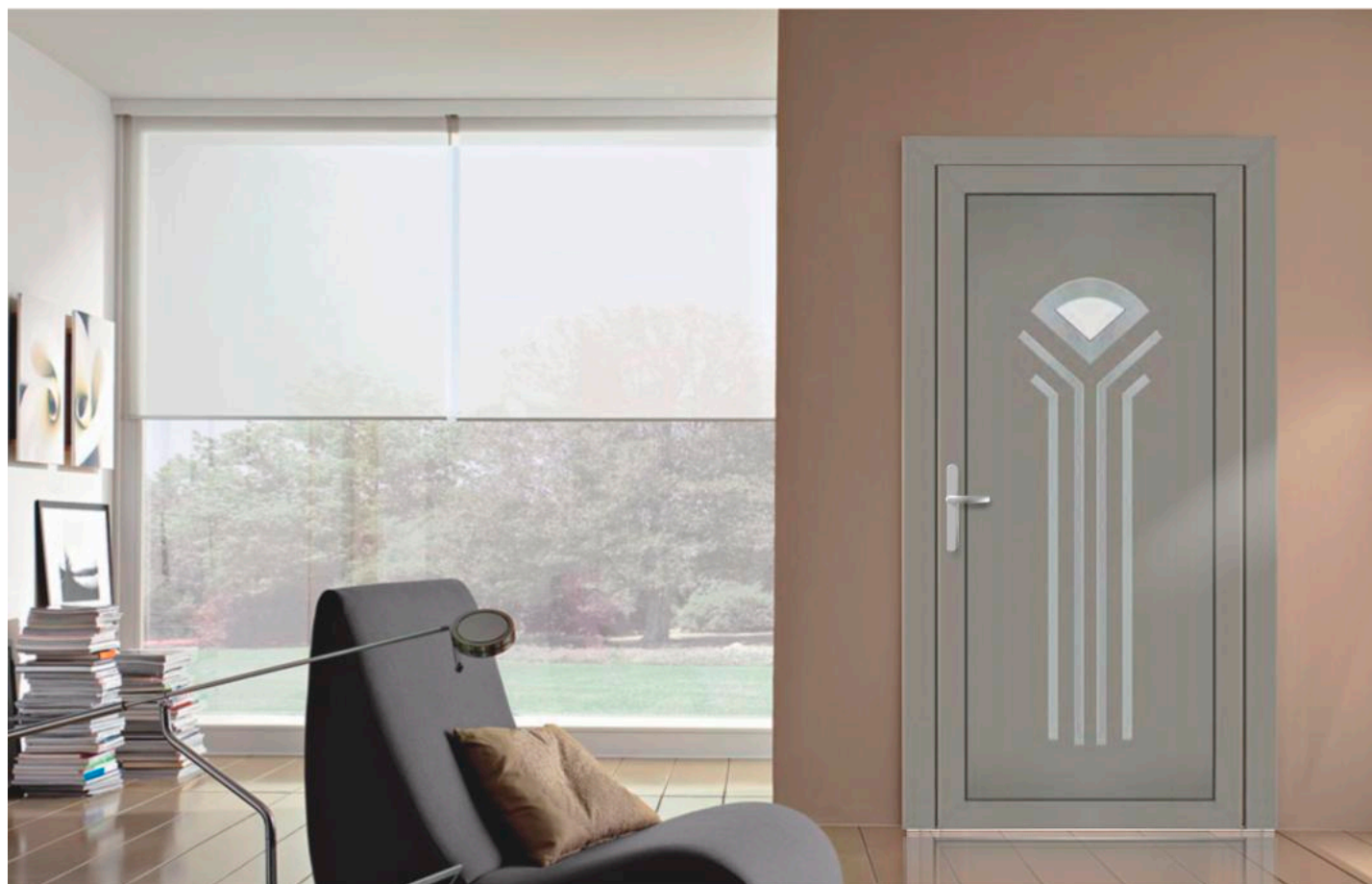

DRU 14

Serie
Termica
Bugnata

10



La serie TERMICA BUGNATA e' alle origini dell'azienda. Ispirata alle forme classiche, e' sempre stata molto apprezzata per la sua eleganza e grazie alle sempre numerose richieste, ne abbiamo ulteriormente elevato gli standard costruttivi.

Se anni fa questi modelli erano sviluppati solo su base PVC, oggi la serie Bugnata viene realizzato solo in Alluminio ed e' possibile colorarla grazie ad una verniciatura elettrostatica con una grande varieta' di colori RAL ed effetto legno.





Cora



Paula



Siria



Ella



Vera



Corina



Celia



Carmen



Greta



Dora



Rebeca



Renata



Marina



Marta



Mara



Le diversita' cromatiche caratterizzano questa serie. La verniciatura elettrostatica mantiene i colori inalterati nel tempo permettendoci di realizzare un prodotto Premium.

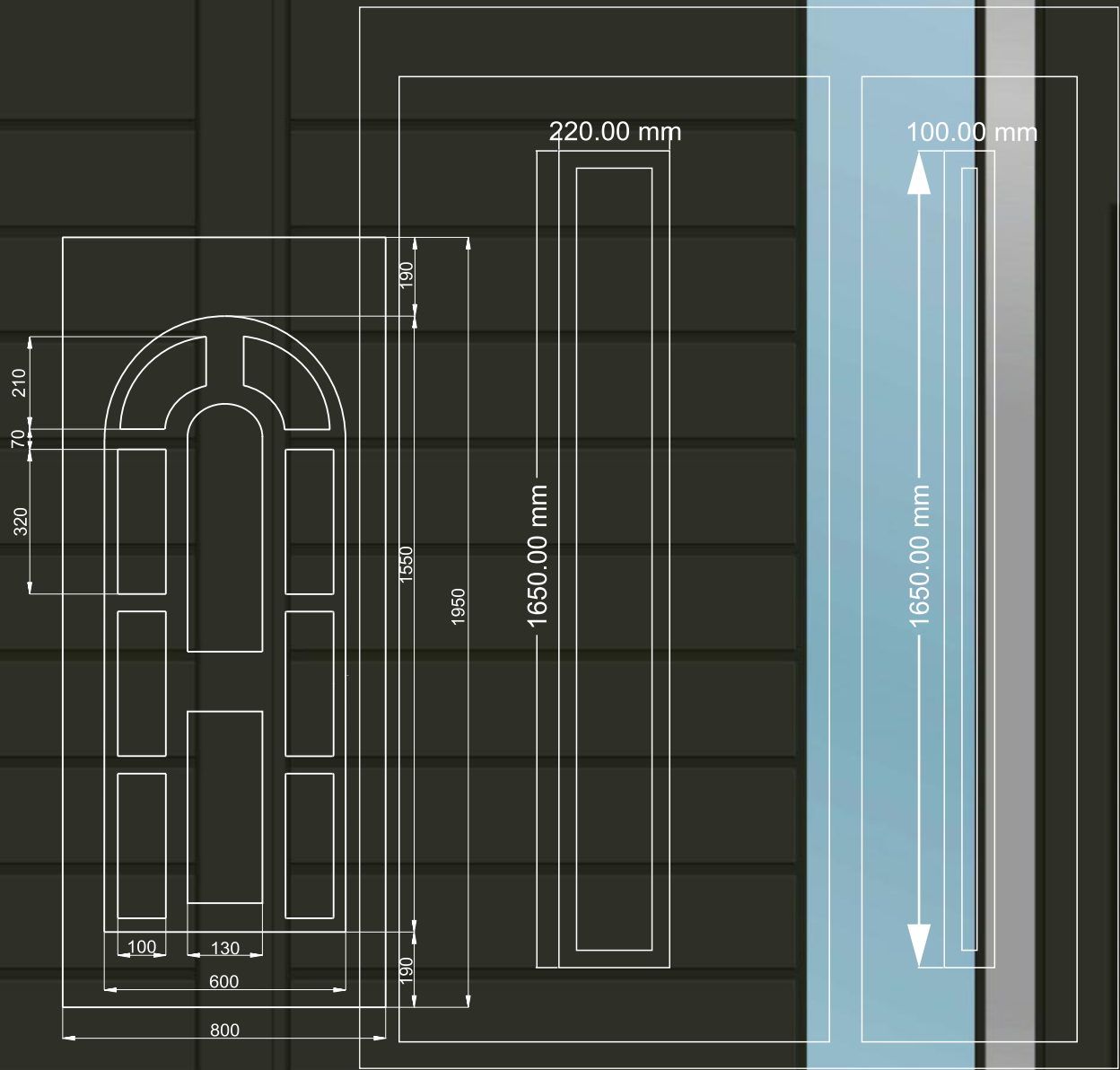

Dimensioni
tecniche

Alle dimensioni minime descritte, bisogna aggiungere minimo 30 mm per lato.

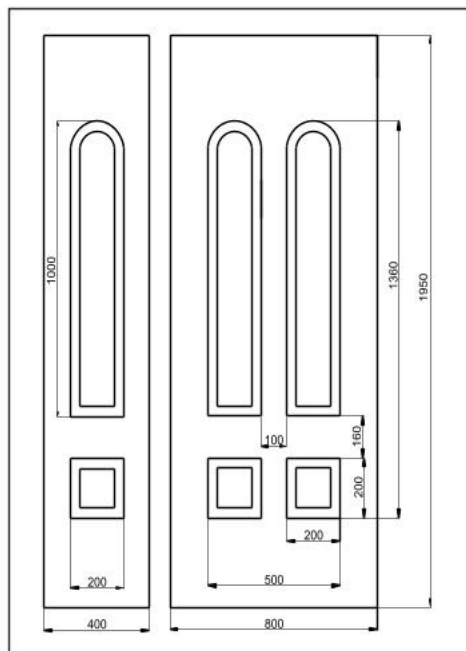

CARMEN

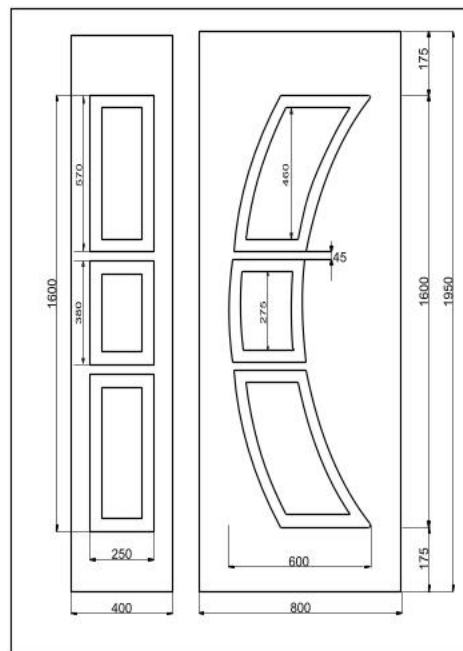

CELIA

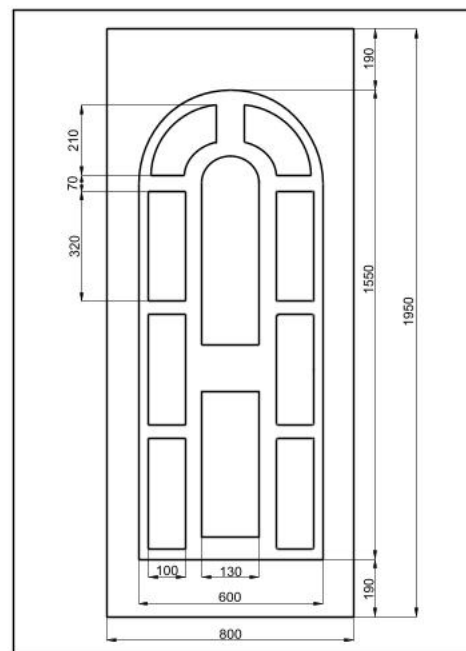

SIRIA

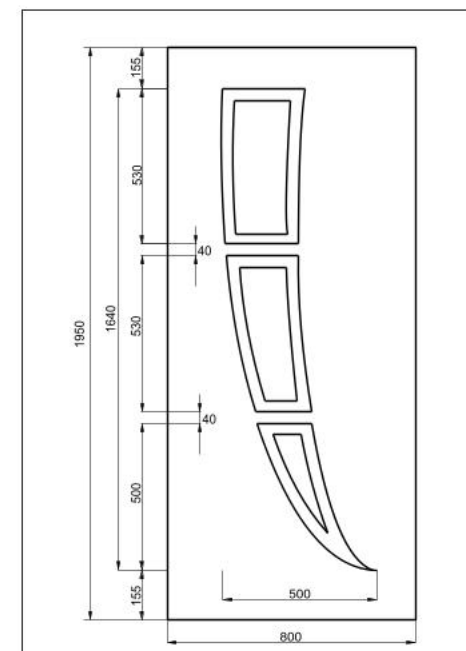

CORA

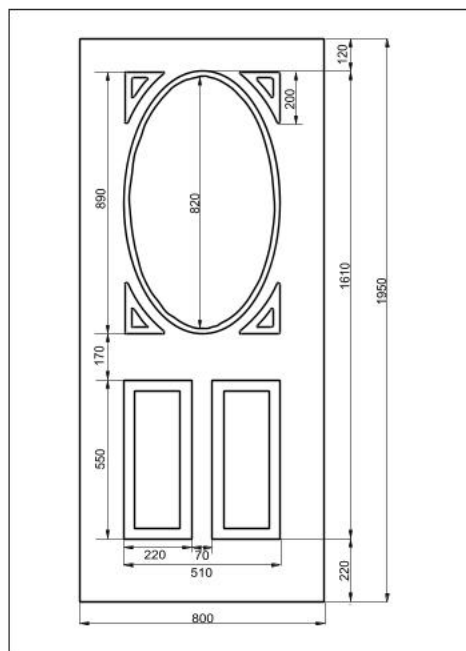

CORINA

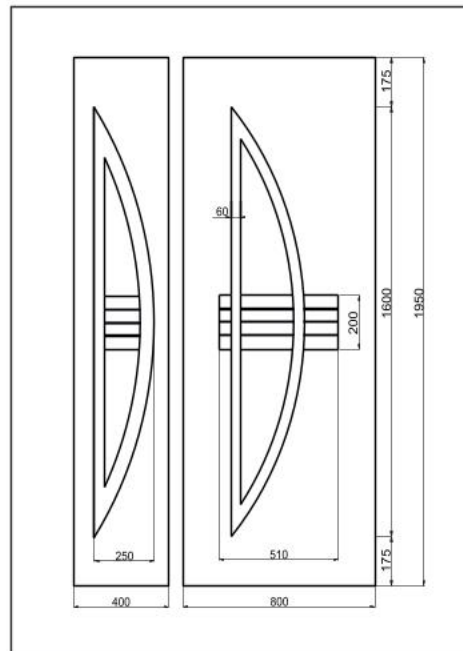

GRETA

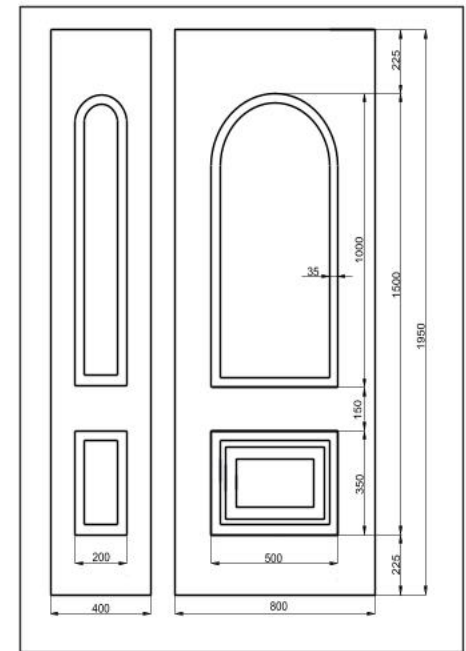

MARTA

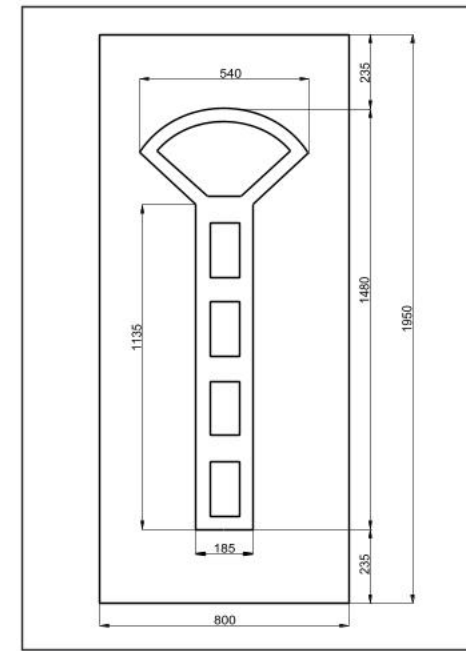

DORA

Alle dimensioni minime descritte, bisogna aggiungere minimo 30 mm per lato.

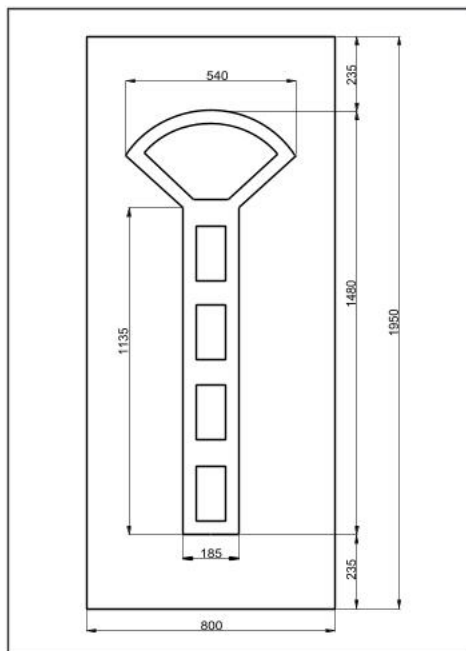

DORA

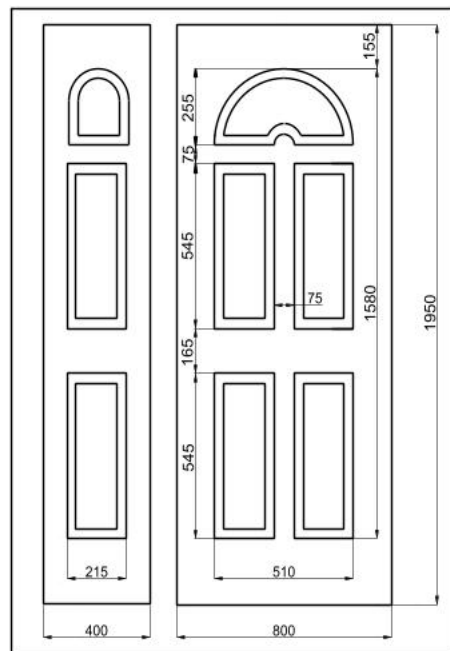

REBECA

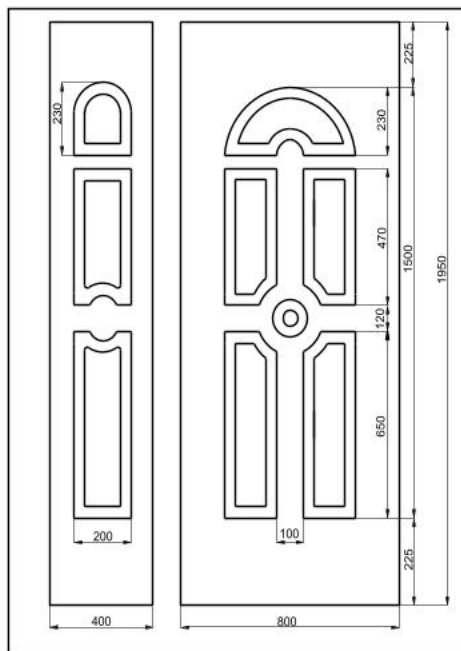

RENATA

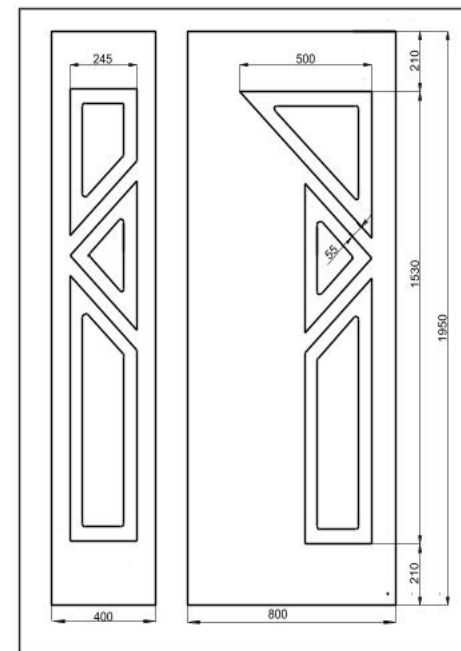

PAULA

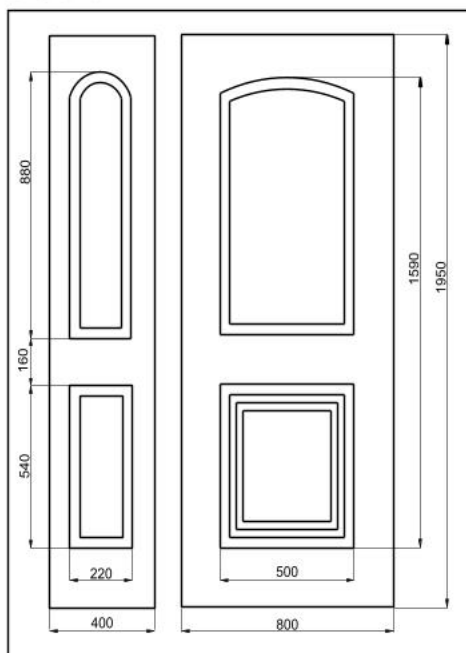

VERA

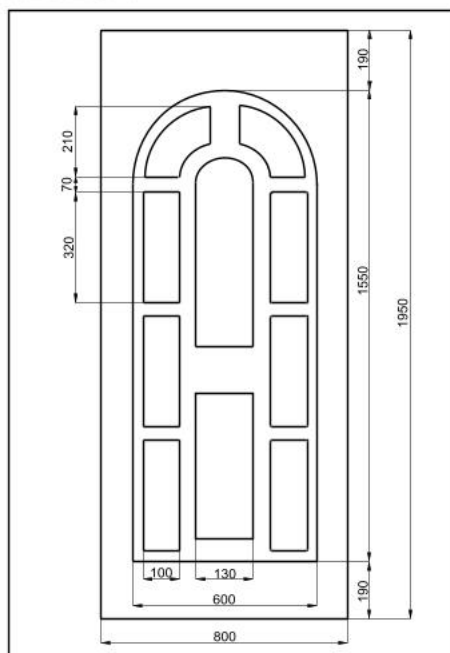

SIRIA

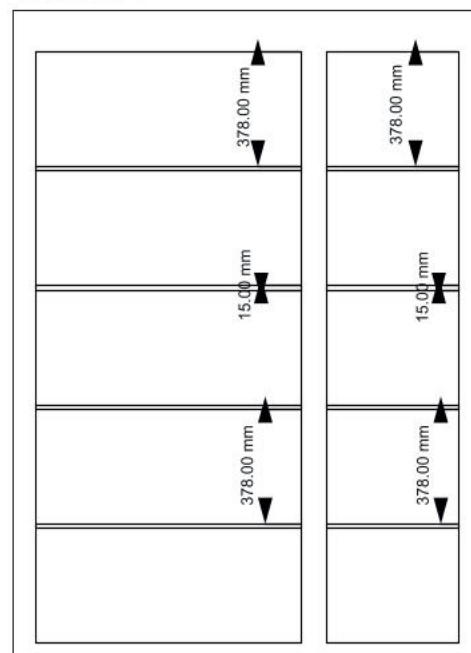

T 1436

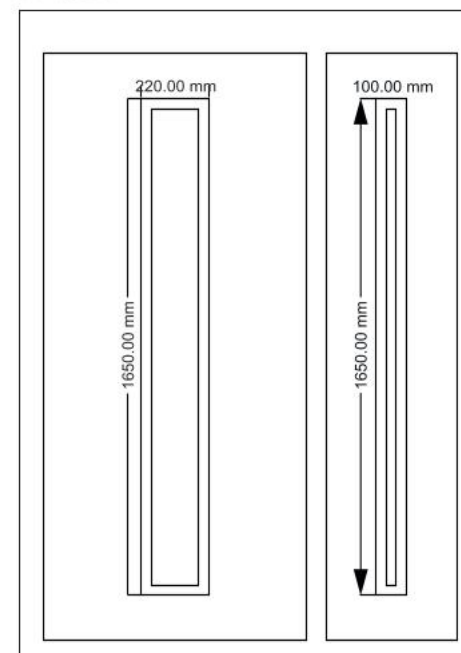

T 1428

Alle dimensioni minime descritte, bisogna aggiungere minimo 30 mm per lato.

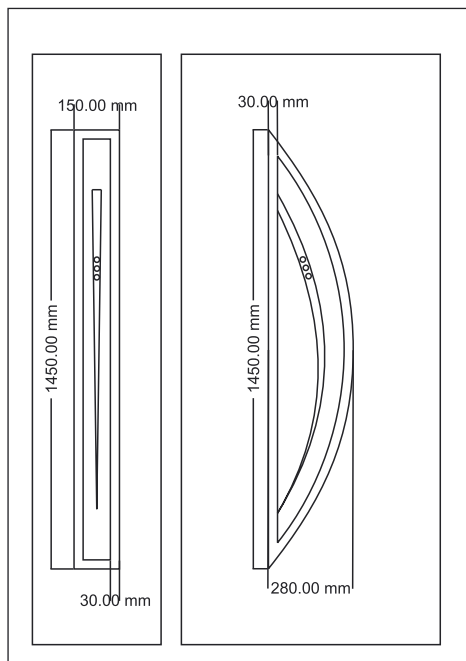

T 1425

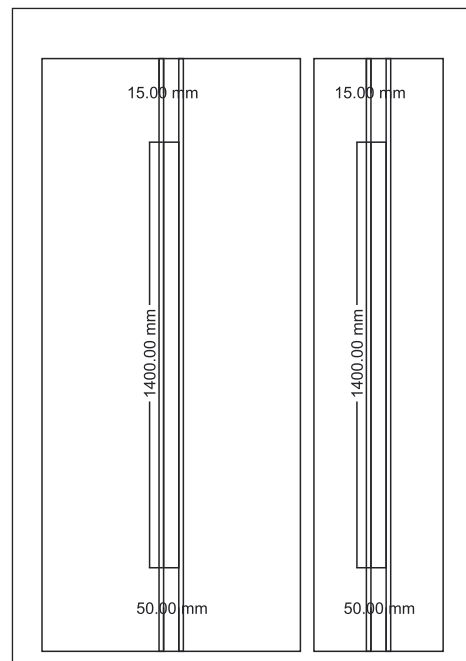

T 1421

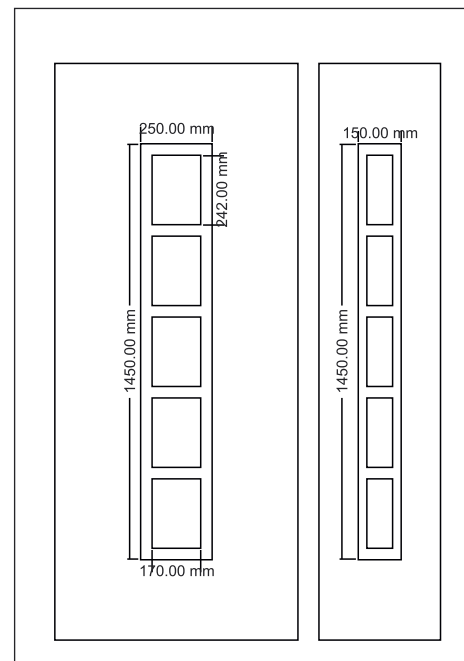

T 1401

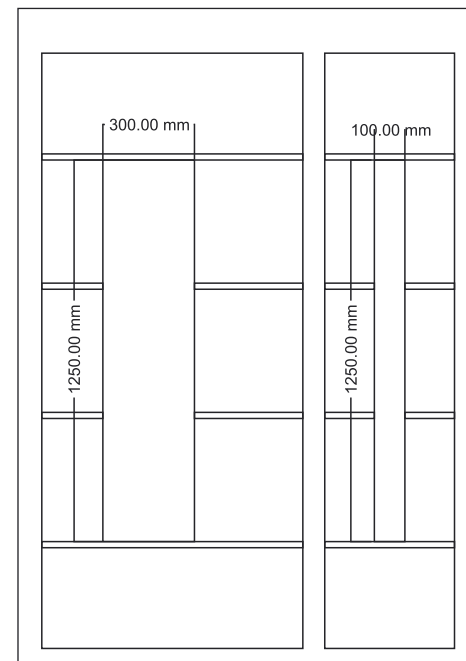

T 1473

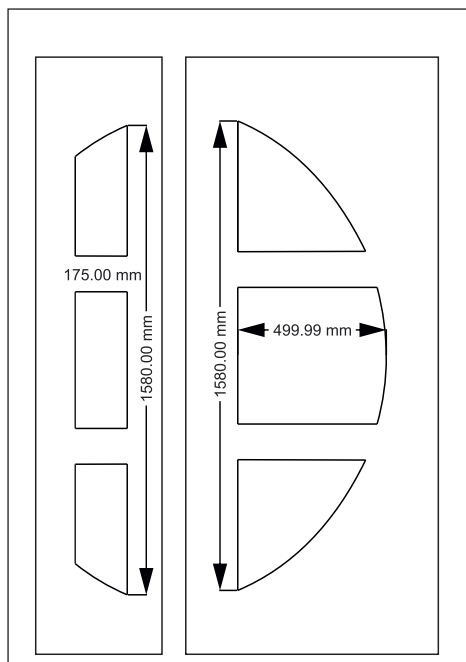

T 1412

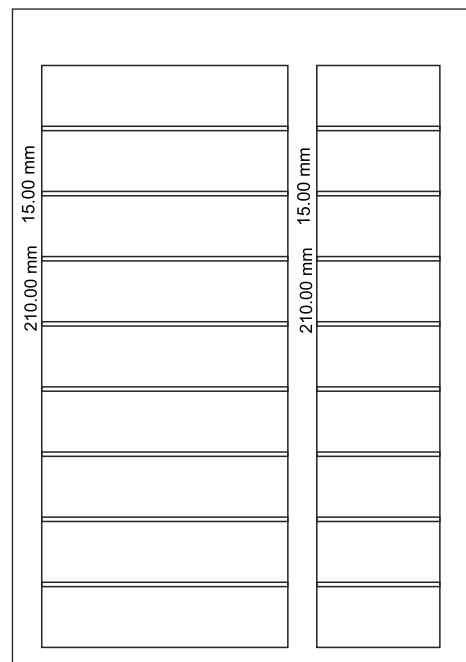

T 1404

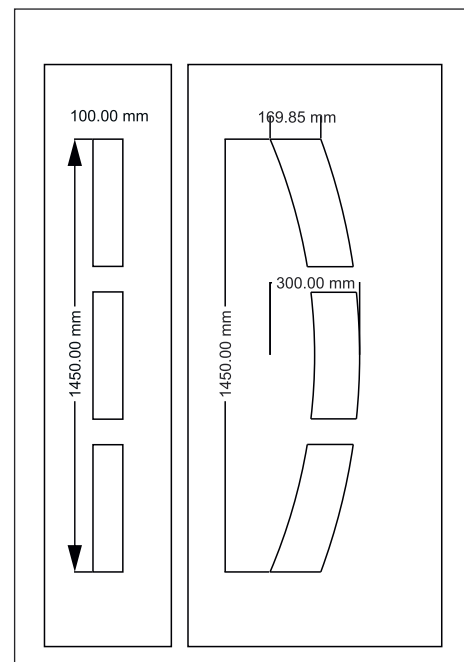

T 1432

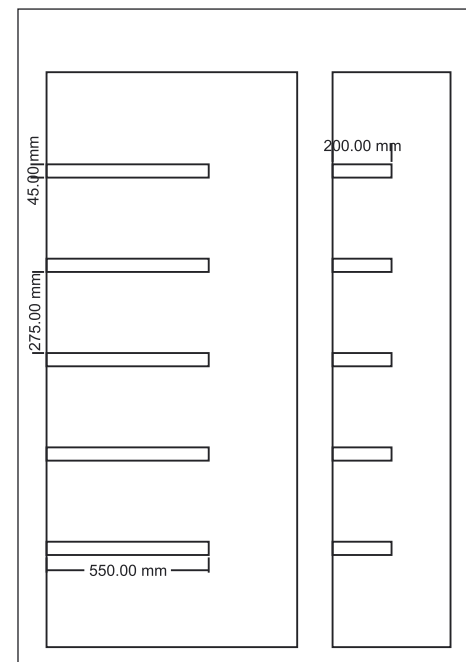

T 1406

Alle dimensioni minime descritte, bisogna aggiungere minimo 30 mm per lato.

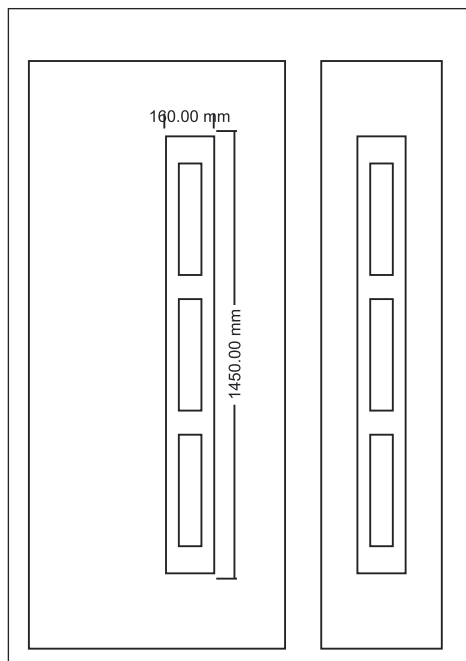

T 1407

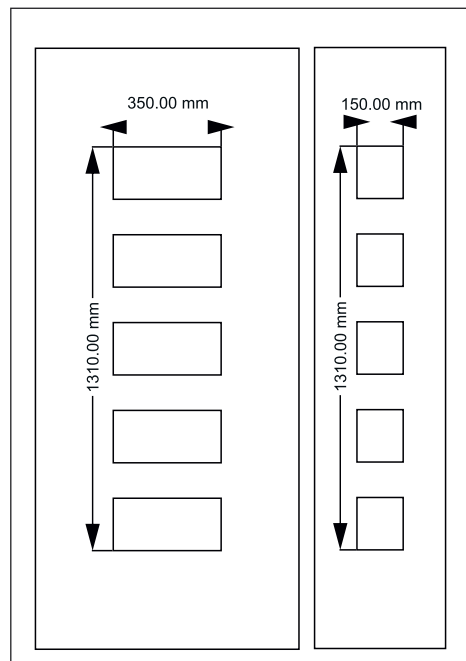

T 1482

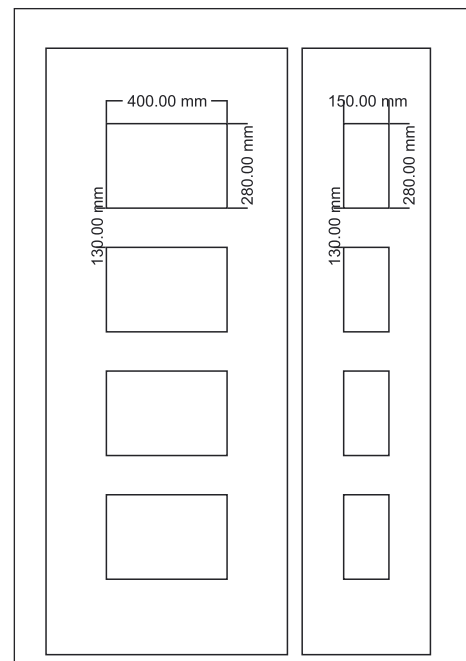

T 1430

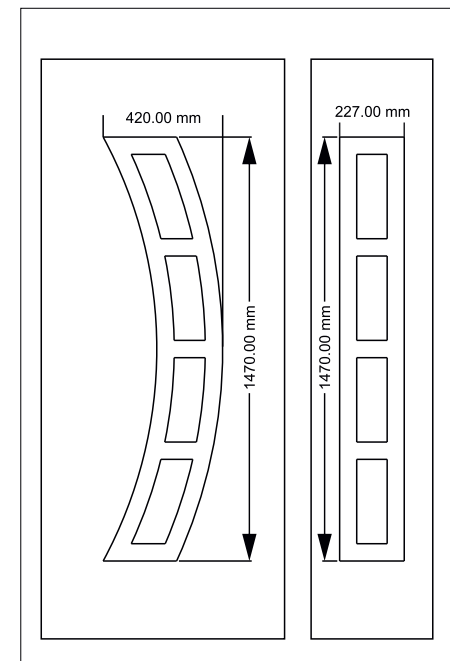

DRU6

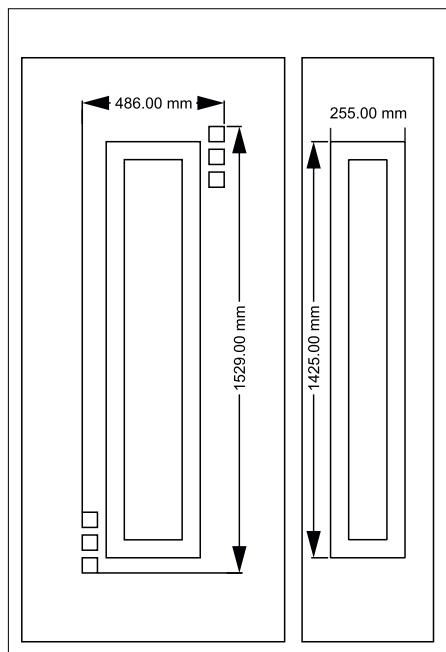

DRU7

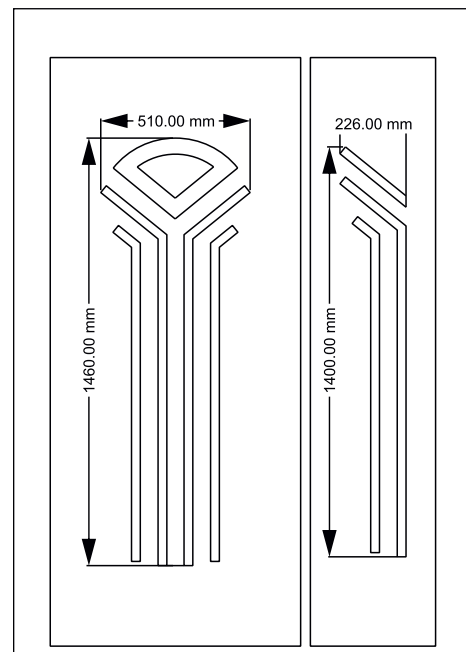

DRU5

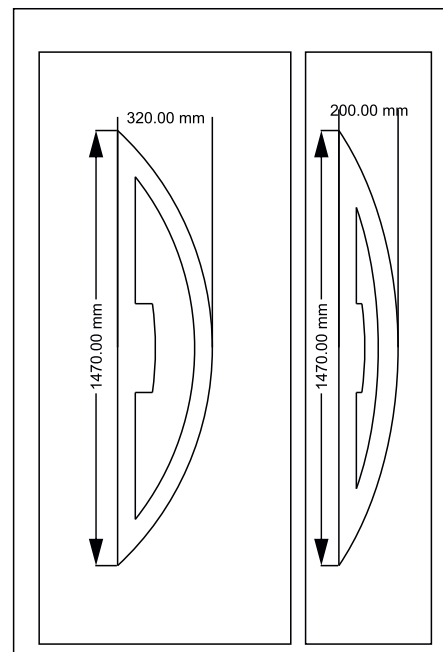

DRU9

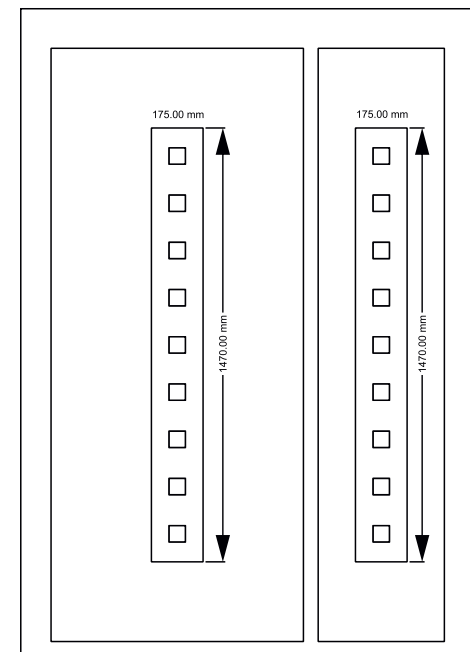

DRU1

Alle dimensioni minime descritte, bisogna aggiungere minimo 30 mm per lato.

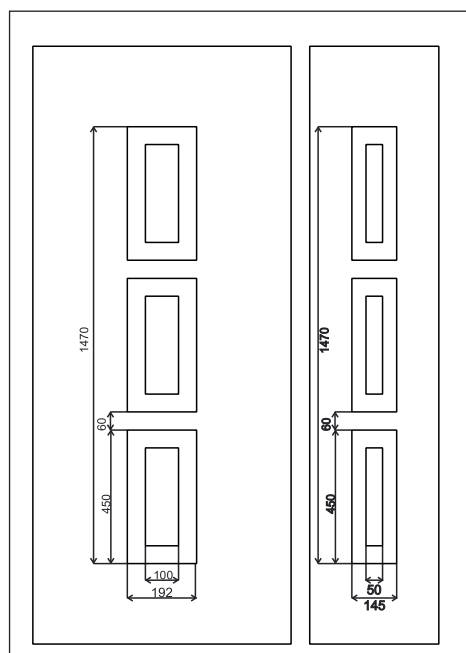

DRU2

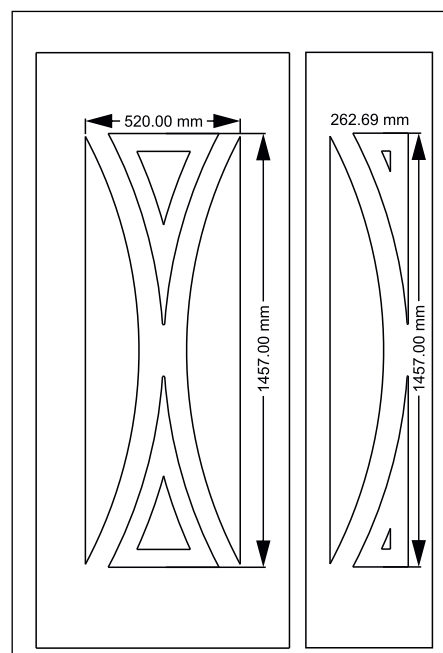

DRU3

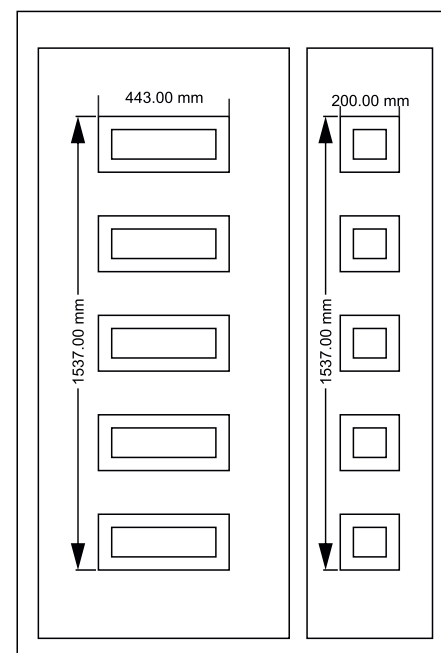

DRU4

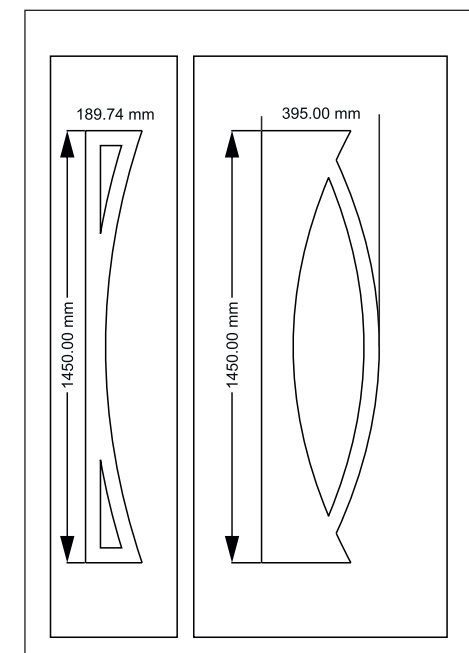

T 1419



Ter 001

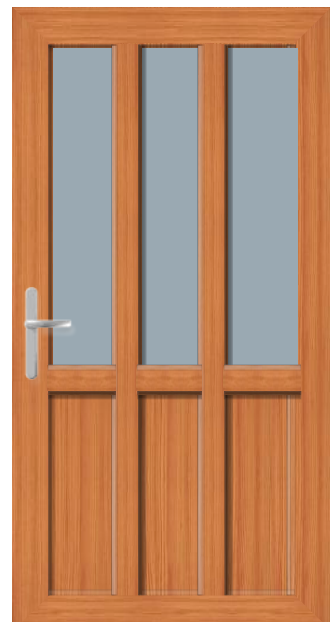

Ter 002



Ter 003



Ter 004



Ter 005



Ter 006



Ter 007



Ter 008



Ter 009



Ter 010



Ter 011



Ter 012



Ter 013



Ter 014



Ter 015



Ter 016



Ter 017



Ter 018



Ter 019



Ter 020



Ter 021



Ter 022



Ter 023



Ter 024

Le porte della serie Ter possono essere realizzate su ordinazione, in qualsiasi dimensione e colore dalla tavolozza di Salamander

Vetri



Vetro 28 mm

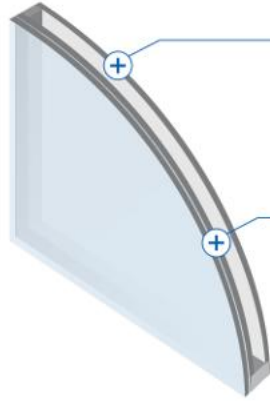

Parte interna

4 MAT

Parte esterna (vetro di sicurezza)

VSG 33.1 SATINATO

Vetro 36 mm

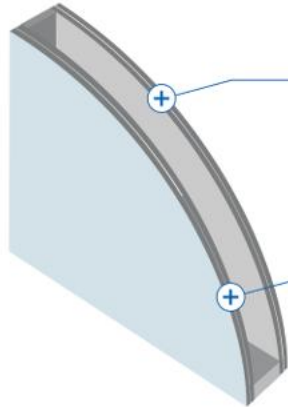

Parte interna (vetro di sicurezza)

VSG 33.1 SATINATO

Parte esterna (vetro di sicurezza)

VSG 33.1 SATINATO

Vetro 44 / 52 mm

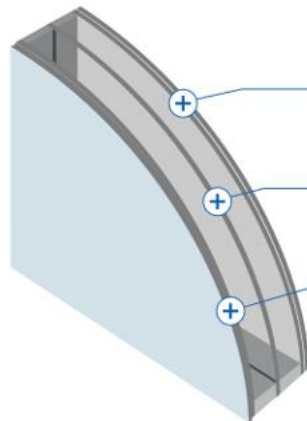

Parte interna (vetro di sicurezza)

VSG 33.1 SATINATO

vetro centrale

4 mm

Parte esterna (vetro di sicurezza)

VSG 33.1 SATINATO





Vetro termoisolante

Oggi puoi beneficiare di una vetrata termoisolante con 2 o 3 vetri, con spessori fino a 52mm, la composizione può essere fatta con vetro basso emissivo, un vetro di sicurezza, un vetro ornamentale, sempre nel rispetto delle normative vigenti.

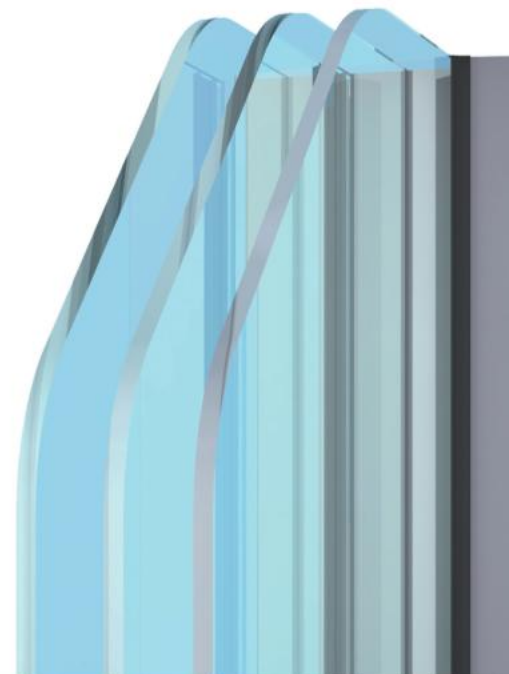

Confort termico e acustico

I nostri vetri ti assicurano un confort termico ed acustico ideale per tutte le stagioni. Ti offrono la tranquillità necessaria per goderti in completo relax i tuoi momenti più intimi e mantengono il confort termico che tu richiedi, indipendentemente dai capricci delle stagioni.



Termica PLUS / WarmEge / Swisspacer

La canalina Warm Edge, ottimizza le nostre vetrate perche' realizzata in materiale plastico composito studiato per alte performance isolanti.

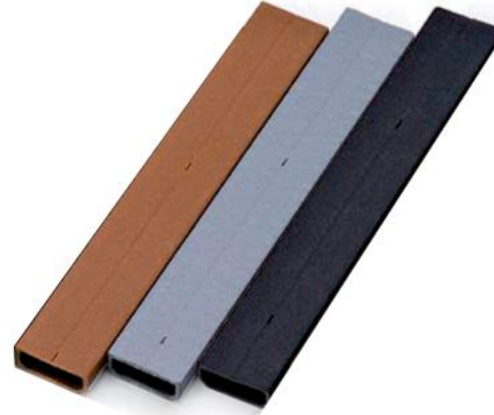

Vetro ornamentale

Consulenza

Con una vasta gamma di vetri a disposizione, i nostri specialisti sono a disposizione per qualsiasi consulenza per scegliere assieme a te il vetro migliore per ogni esigenza, dal punto di vista termico, acustico, e della trasmissione luminosa.

Oltre alla funzione decorativa, il vetro presenta 2 vantaggi importantissimi: intimita' personale e un'ottima luminosita' per la tua stanza.



Colori

Infinite possibilita

I colori rappresentano la nostra personalita' e sono un elemento importante per la nostra armonia. Termica mette a disposizione una gamma importante di colori per la porta di casa, per questo puo' essere abbinata al colore di casa, agli scuri esterni, ai mobili interni.

Colori disponibili



Golden-Oak 51



Nußbaum 21



Mooreiche 25

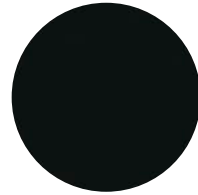

Anthrazitgrau 55

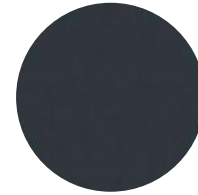

Anthrazitgrau Satin 88

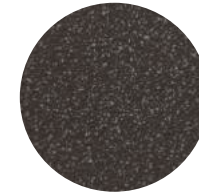

Alux DB703 37



Polareiche 43



mattAlpine_COOLWood 92



mattMalt_COOLWood 91



White Ash 35



Streifen-Douglasie 27



Nebraska 33



Tiama 62

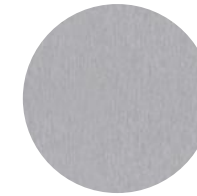

Metbrush Alu 69



Methbrush Brass 38



Weis antik 39



Creme 59

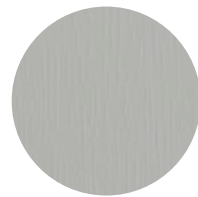

Lichtgrau 73

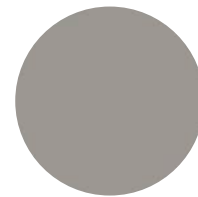

Silver grey 42

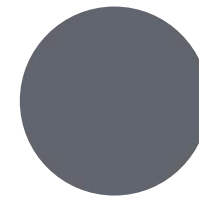

Basaltgrau 74

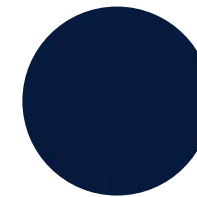

Stahlblau 11

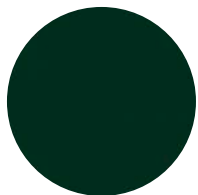

Dunkelgrün 03



Schwarzbraun 71



Quarzgrau Satin 90

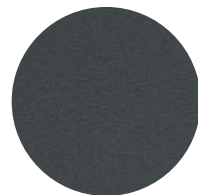

Basaltgrau Satin 84



Schwarz matt Satin 98



Jet black Satin 18



Ferramenta
e accessori





- Bianco
- Bronzo
- Argento
- Oro lucido
- Inox



Maniglione Inox
TG 10.ER.GS

L	
330	1000
400	1200
500	1400
600	1600
800	1800



Maniglione Inox
TG 10.ER.GKL

A=300
A=350



Maniglia
Antieffrazione

cilindro antieffrazione

- Bianco
- Marrone
- Bronzo
- Argento
- Oro lucido



Pomolo
Esterno

Colore Inox



Defender colore Inox



A richiesta: Cilindro con Farfallina interna



Serratura antieffrazione SZ2

Dotazioni Standard.

5 punti di chiusura:

N° 2 rostri con gancio a Becco di pappagallo in acciaio (escono con l'azionamento della chiave).

N° 2 rostri in acciaio automatici (escono in automatico con la chiusura della porta, senza l'utilizzo della chiave di chiusura).

N° 1 rostro centrale (esce con l'azionamento della chiave).

N° 3 controplacche in acciaio.

Benefici:

Massima sicurezza antieffrazione.

Ottima sicurezza anche senza l'utilizzo della chiave di chiusura.

Tenuta ottimale della porta di ingresso.

Spessore rinforzi in acciaio:

Spessore acciaio interno ai profili:

Da 2 a 3 mm

Soglia a taglio termico in alluminio:

Standard: Soglia ribassata a taglio termico da 20mm

Optional:

Lama parafreddo (Ghigliottina):

La lama parafreddo scende automaticamente dall'anta al momento della chiusura della porta.



Particolare:
Rostro + Gancio
a becco di pappagallo

Soglia di sicurezza eifel

Con un alto grado di sicurezza la soglia Eifel e' stata concepita espressamente per le porte di ingresso. Un sistema unico, piu' sicuro ed ermetico rispetto a tutti gli altri prodotti presenti sul mercato

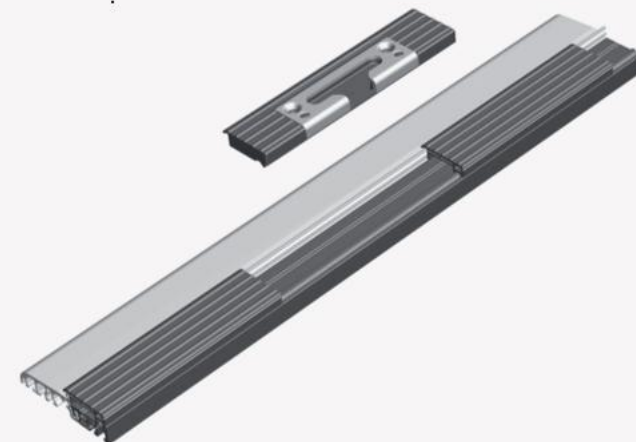

Cerniera Stylo

Design moderno e minimale, la cerniera Stylo permette una regolazione in 3D (tridimensionale) garantendo una notevole tenuta ed una semplice regolazione della porta.



● Argento



Cerniera Termica

Le cerniere TERMICA, totalmente realizzate in metallo, permettono una regolazione sui 3 assi permettendo un incremento della tenuta ed una agevole regolazione della porta, con un portata fino a 120 kg

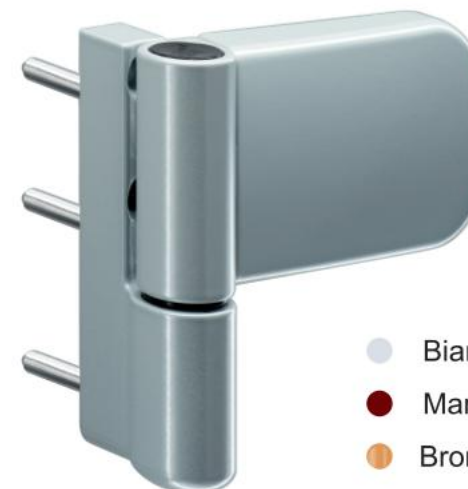

- Bianco
- Marrone
- Bronzo
- Argento

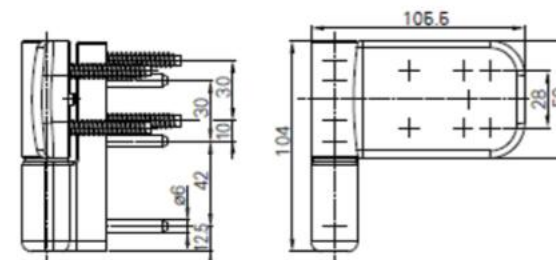



Il vostro Feedback e' molto importante per noi perche' ci permette di migliorare costantemente. Per informazioni potete contattarci ai numeri:



www.serramenti-termica.it

